

# Solder Alloy choice for through hole ceramic discoidal & planar array capacitors

<a href="#">Introduction</a>	2
<a href="#">Introduction to through hole ceramic capacitors</a>	3
<b><u>Part 1 – The effect of solder alloy choice with respect to stress release cracking in gold plated through hole ceramic capacitors</u></b>	
<a href="#">General soldering trials</a>	5
<a href="#">Investigation into cause of cracks</a>	7
<a href="#">Solder alloy trials</a>	9
<a href="#">Results</a>	10
<a href="#">Solder Type 62Sn/36Pb/2Ag</a>	10
<a href="#">Solder Type 60Sn/40Pb</a>	11
<a href="#">Solder Type 99.3Sn/0.7Cu</a>	12
<a href="#">Solder Type 95.5Sn/3.8Ag/0.7Cu</a>	13
<a href="#">Solder Type 50In / 50Pb</a>	14
<a href="#">Solder Type 95Pb / 5In</a>	15
<a href="#">Solder Type 93.5Pb/5Sn/1.5Ag</a>	16
<a href="#">Results Summary</a>	17
<b><u>Part 2 – The effect of lead free soldering to PdAg plated terminated through hole ceramic capacitors</u></b>	
<a href="#">Demonstration of effect with PdAg termination</a>	18
<a href="#">Testing PdAg termination and Pb free solder alloy</a>	19
<a href="#">Analysis of the Cause of failure</a>	21
<a href="#">Analysis of the differences between gold plate and PdAg terminations</a>	23
<a href="#">Comments on fritted termination in discoidal and planar capacitors</a>	26
<a href="#">Overall Conclusions</a>	27
<a href="#">RoHS compliance</a>	28



Application Note  
Reference No. AN0011  
Solder Alloy choice for  
through hole ceramic  
discoidal & planar array  
capacitors Issue 3

Page No.: 2 of 28

## Introduction

It has been well known for a number of years that solder alloy choice is a critical factor in soldering to ceramic discoidal and planar array capacitors. The introduction of lead free solder alloys as a result of the EU directive 2002/95/EC (the RoHS directive) has prompted further investigation into this phenomenon to categorise the effects of these alloys.

This application note aims to demonstrate the effect the choice of solder alloy has when soldering to the internal bore of these through hole capacitors.

## Introduction to through hole ceramic capacitors

Through hole ceramic capacitors are based on the technology of multi layer chip capacitors (MLCC's) with modified internal architecture. The manufacture is similar to MLCC's in that layers of ceramic dielectric material interlaced with precious metal electrodes are built up to form the structure, but holes are then drilled in the ceramic to form contacts to the inner or hot electrodes. The outside is machined to shape and makes contact to the outer or cold electrodes. The capacitance is formed between the hole and the outside edge. In the case of planar arrays, capacitance is formed between each hole and the outside edge. Within limits, each hole can have different capacitance characteristics.

Single hole devices are usually referred to as discs (they are not necessarily circular) whilst multi hole devices are referred to as planar arrays.

The materials involved are typically BaTiO<sub>3</sub> ceramic dielectric with PdAg electrodes. Terminations are usually plated Au over Ni directly onto the ceramic surface, or sometimes PdAg based fritted glass solderable terminations.

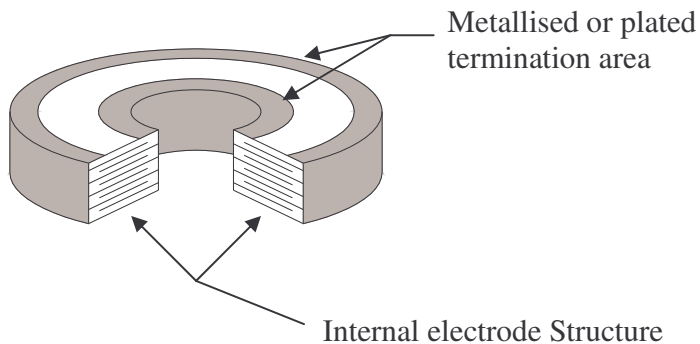

FIG 1  
TYPICAL DISCOIDAL  
CONSTRUCTION

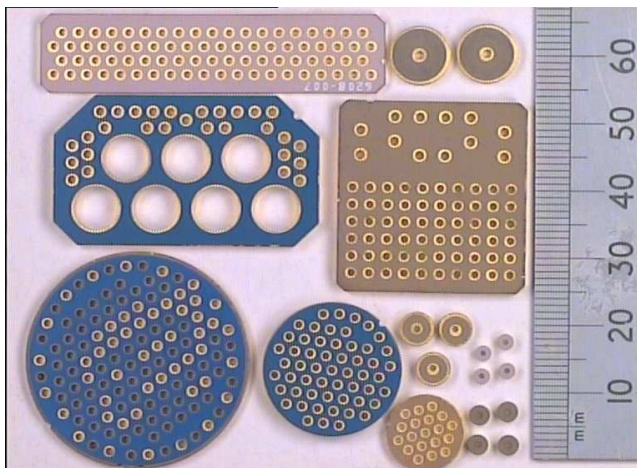
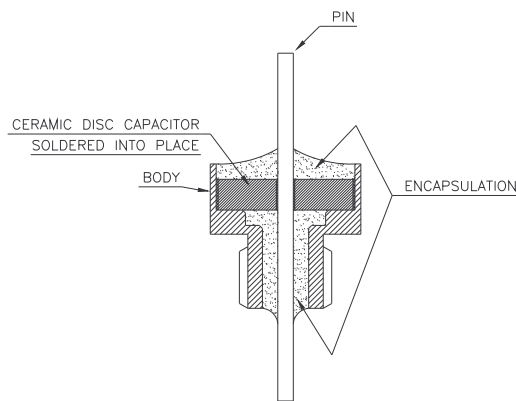

FIG 2  
EXAMPLES OF DISCOIDAL  
AND PLANAR ARRAY  
CAPACITORS

The finished capacitor device is used in the assembly of EMI filters and filter assemblies. Their special construction allows the devices to have superior high frequency performance to SM chip based filtering – important for applications such as military, aeronautical and medical. For the construction of an EMI filter, the discoidal or array is soldered into a carrying can, or body, with a pin soldered through the centre. The assembly can then be encapsulated to give improved mechanical and environmental protection. The signal to be filtered is passed through the pin and the outside of the body connected to earth.

The pin and body are usually manufactured from Cu or Cu based alloys, plated with Ag or Au.



**FIG 3**  
TYPICAL EMI FILTER  
CONSTRUCTION

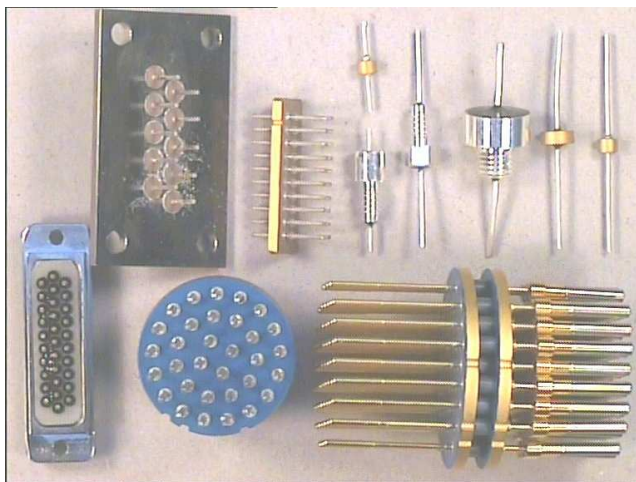

**FIG 4**  
EXAMPLES OF EMI FILTERS  
AND ASSEMBLIES

### General soldering trials

It has been acknowledged for some years that soldering to the internal bore of the capacitor had the potential to induce cracks within the ceramic structure. The cracks generated by this process are known as ‘Longbow’ or ‘Comma’ cracks from their distinctive shape when viewed from a side cross section or top cross section respectively.

These cracks can be benign or can cause total electrical failure, dependant on whether they pass through the area of electrode overlap. Possibly of more concern, the cracks can be instigated during soldering, but only propagate during further processing or in use, whereupon the capacitor can fail in operation.

Capacitor failure will always tend towards a short circuit. If there is sufficient electrical power available, the part will then become extremely hot and can represent a source of combustion.

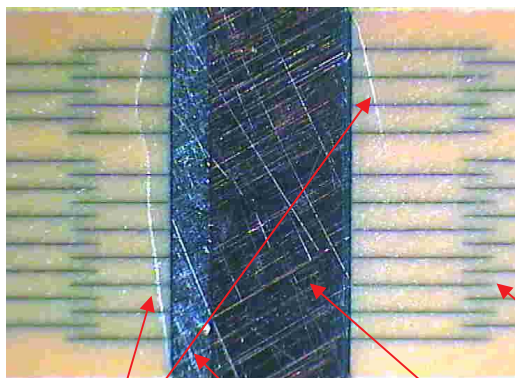

CRACKS

SOLDER JOINT

CERAMIC CAPACITOR

COPPER ALLOY PIN

FIG 5

‘LONGBOW CRACK’

Capacitor soldered using 62Sn/36Pb/2Ag solder. Crack in dielectric material generated during cooling of solder joint after reflow.

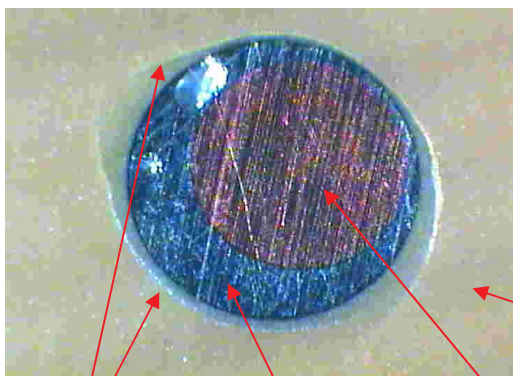

CRACKS

SOLDER JOINT

CERAMIC CAPACITOR

COPPER ALLOY PIN

FIG 6

‘COMMA CRACK’

The same crack as in FIG 3 above, but sectioned through a plane 90° displaced.

A further form of crack commonly found in through hole ceramic capacitors is the corner crack. This occurs when the solder fillet on the surface pad shrinks causing the ceramic to crack and lift. It can be likened to the effect of pad lift on a circuit board.

Corner cracking is less critical than longbow / comma cracking and rarely threatens immediate outright dielectric failure, although the induced crack can propagate in operation causing failures. It can be eased by limiting the volume of solder in the meniscus or reducing the pad size. On very small size parts, it is common to remove the pad entirely.

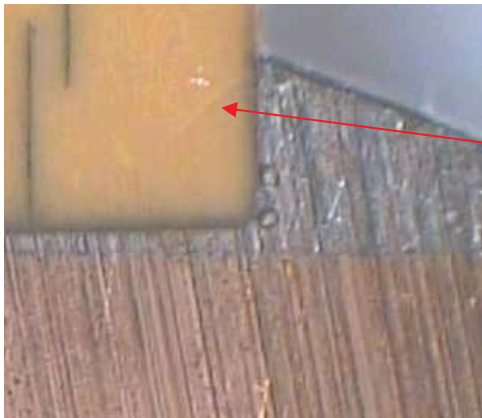
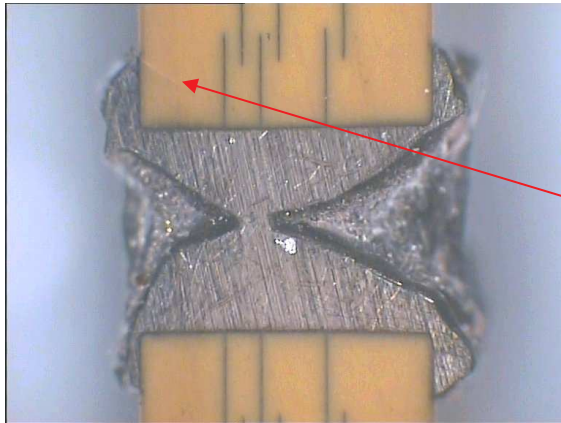

FIG 7  
'CORNER CRACK'

Crack generated by lifting of the pad due to the solder meniscus

### Investigation into cause of cracks

Investigation into causes of the cracks centred on the solder profile. In particular, it was felt important to understand whether the crack occurred during the heating or cooling portion of the solder profile. To this aim, an array was assembled using 62Sn/36Pb/2Ag solder and the solder was reflowed using a five zone hot air reflow furnace. As the array passed out of the final soldering zone, a number of pins were removed. After cleaning and drying, the array was sectioned and the internal structure analysed – cracks were found in the structure around holes with pins still in place. Where the pins had been removed no longbow cracks were present.



**FIG 8**

Example of solder joint from which pin has been removed before solder has solidified

Note small corner crack caused by solder meniscus

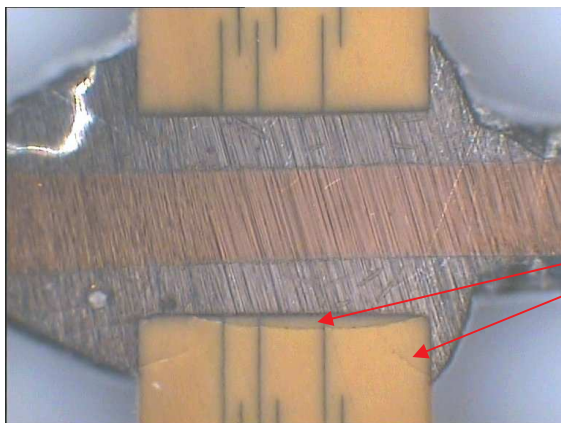

**FIG 9**

Example of solder joint with pin in place

Note longbow crack and corner cracks



This showed that the cracks only occur during the cooling portion of the soldering profile, and that pins must be present to generate the forces that form the longbow crack. This shows that the forces exerted on the ceramic are external to the capacitor.

Considering the forces being generated during the cooling cycle, it is clear that the critical force is generated by the shrinkage of the solder / pin as it cools. This force is generated by the mismatch between the shrinkage amount and rate of the ceramic / solder / pin interconnection. To prevent the cracking it is necessary to change the properties of this interconnection.

The ceramic and the pin materials are fixed and cannot be changed, therefore we need to investigate the solder conditions that are needed to prevent the cracks from forming.

## Solder alloy trials

To analyse the effects of different solder alloys, a set of trials were carried out using the following alloys :-

62Sn/36Pb/2Ag	Traditional LMP solder
60Sn/40Pb	Traditional solder
99.3Sn/0.7Cu	Lead free 'plumbers' solder
95.5Sn/3.8Ag/0.7Cu	Lead free solder recommended for PCB assembly
50Pb/50In	Ductile stress relieving solder
95Pb/5In	Ductile stress relieving HMP solder
93.5Pb/5Sn/1.5Ag	Ductile stress relieving HMP solder

This matrix represents the solders currently in use for the assembly of EMI filters, conventional tin lead solders and samples of lead free proposed replacement solders.

In each case except the 2 HMP alloys, two sample sets of filters were assembled and reflowed using a five zone hot air reflow furnace. Sample 1 had a standard solder profile with forced cooling by air blowers after zone 5. Sample 2 was reflowed using the same soldering profile but with the cooling air blowers turned off to allow gradual cooling, so as to reduce the stresses on the ceramic.

95Pb/5In solder has a high melting point of 300°C/313°C, and 93.5Pb/5Sn/1.5Ag a high melting point of 296°C/301°C, so neither could be soldered using the available hot air furnace. Instead samples of these were assembled using a hot plate at 425°C. Preheat was not used. Sample 1 parts were force cooled by placing directly in front of a desk fan. Sample 2 parts were allowed to gradually cool.

The samples were then sectioned, allowing the capacitor structure around the solder joints to be inspected for cracking.

## Results

### 1. Solder Type 62Sn/36Pb/2Ag

#### 1.A. 62Sn/36Pb/2Ag Sample 1 (Forced cooling)

80% of the joints sectioned had longbow cracks adjacent to the solder joint. All the joints inspected had some cracking present in the ceramic, mostly corner cracks..

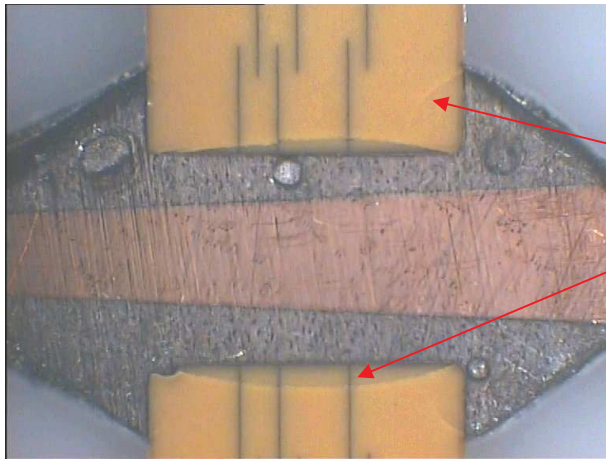
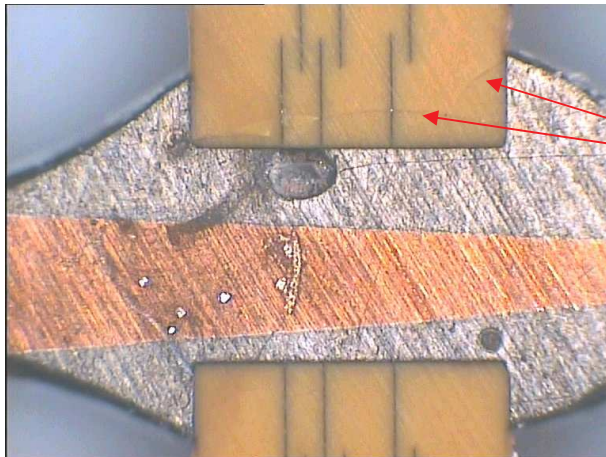

**FIG 10**

Example of force cooled  
62Sn/36Pb/2Ag solder joint  
showing longbow and corner  
cracks

#### 1.B. 62Sn/36Pb/2Ag Sample 2 (Gradual cooling)

20% of the joints sectioned had longbow cracks adjacent to the solder joint. A total of 60% of joints had corner cracks associated with the solder meniscus.



**FIG 11**

Example of 62Sn/36Pb/2Ag  
solder joint showing  
longbow and corner cracks

## 2. Solder Type 60Sn/40Pb

### 2.A. 60Sn/40Pb Sample 1 (Forced cooling)

All of the joints sectioned had longbow cracks adjacent to the solder joint.  
All joints also has corner cracks.

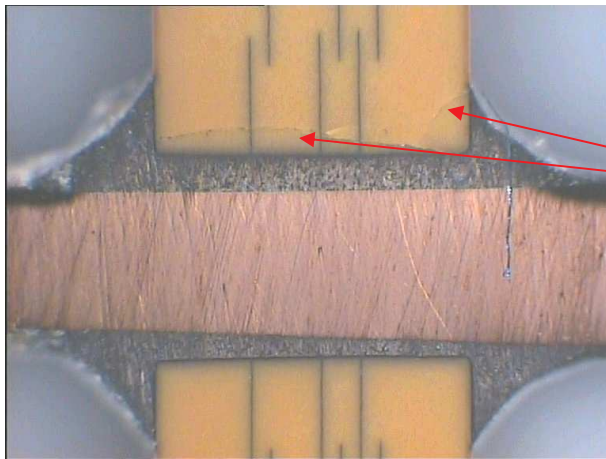
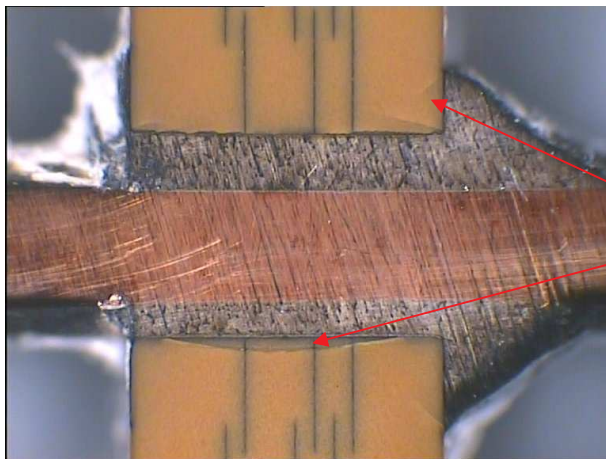

**FIG 12**

Example of force cooled  
60Sn/40Pb solder joint  
showing longbow and corner  
cracks

### 2.B. 60Sn/40Pb Sample 2 (Gradual cooling)

60% of the joints sectioned exhibited longbow cracks adjacent to the  
solder joint. A total of 80% of joints had corner cracks associated with the  
solder meniscus.



**FIG 13**

Example of 60Sn/40Pb solder  
joint showing longbow and corner  
cracks

### 3. Solder Type 99.3Sn/0.7Cu

#### 3.A. 99.3Sn/0.7Cu Sample 1 (Forced cooling)

All of the joints sectioned had longbow cracks adjacent to the solder joint.  
All joints also has corner cracks.

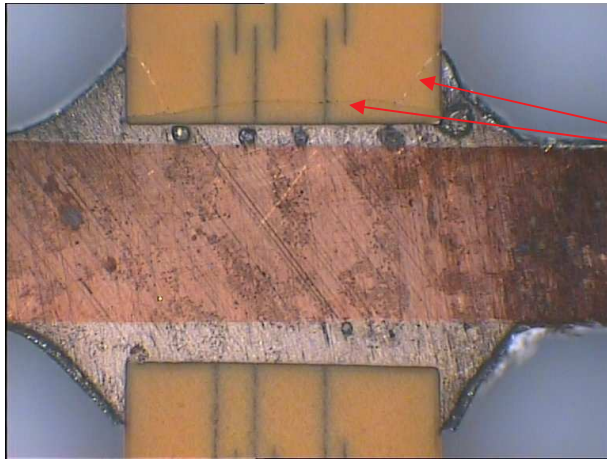
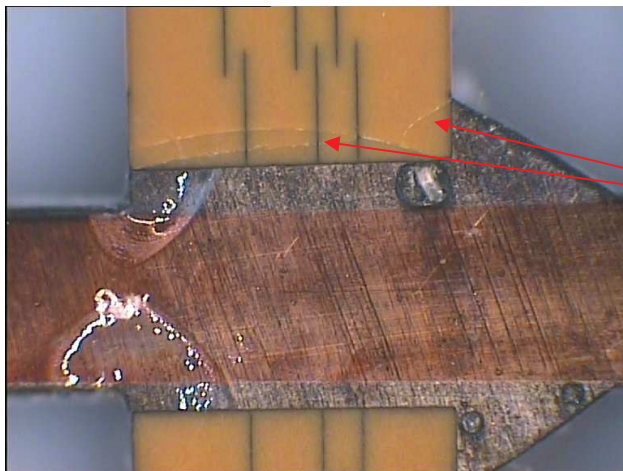

**FIG 14**

Example of force cooled  
99.3Sn/0.7Cu solder joint  
showing longbow and corner  
cracks

#### 3.B. 99.3Sn/0.7Cu Sample 2 (Gradual cooling)

All of the joints sectioned had longbow cracks adjacent to the solder joint.  
All joints also has corner cracks.



**FIG 15**

Example of 99.3Sn/0.7Cu  
solder joint showing longbow  
and corner cracks

#### 4. Solder Type 95.5Sn/3.8Ag/0.7Cu

##### 4.A. 95.5Sn/3.8Ag/0.7Cu Sample 1 (Forced cooling)

All of the joints sectioned had longbow cracks adjacent to the solder joint.  
All joints also has corner cracks.

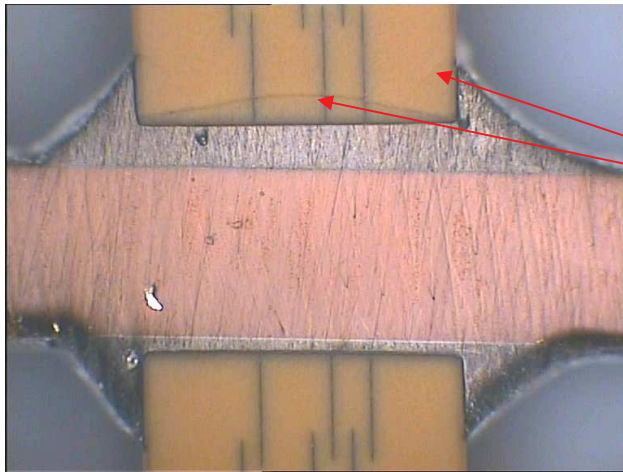
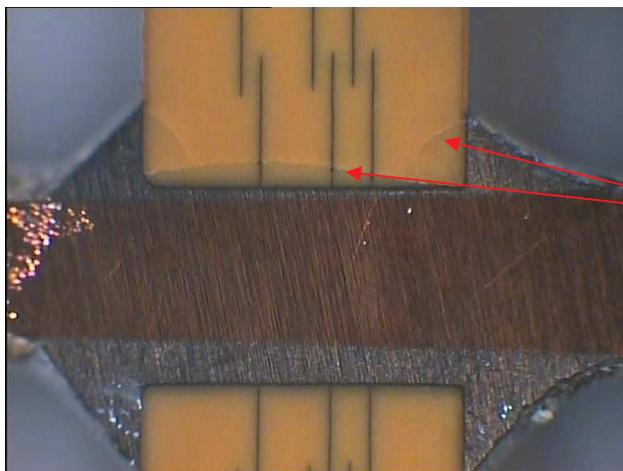

**FIG 16**

Example of force cooled  
95.5Sn/3.8Ag/0.7Cu solder  
joint showing longbow and  
corner cracks

##### 4.B. 95.5Sn/3.8Ag/0.7Cu Sample 1 (Gradual cooling)

40% of the joints sectioned had longbow cracks adjacent to the solder  
joint. 80% of the joints in total had corner cracks, mainly corner cracks  
associated with solder pads.



**FIG 17**

Example of 95.5Sn/3.8Ag/0.7Cu  
solder joint showing longbow and  
corner cracks

## 5. Solder Type 50In / 50Pb

### 5.A. 50Pb/50In Sample 1 (Forced cooling)

None of the joints sectioned exhibited any sign of induced cracks in the ceramic.

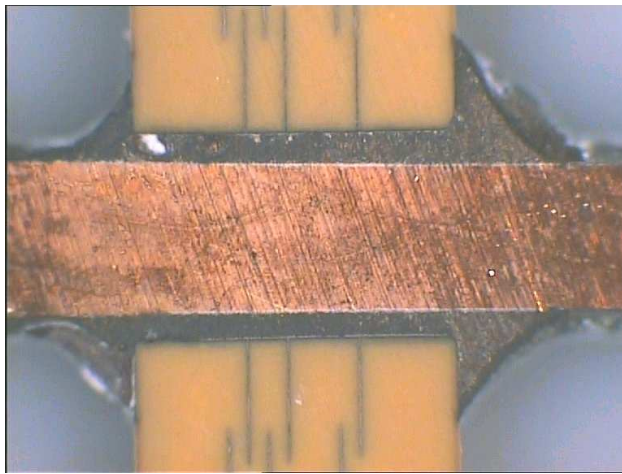
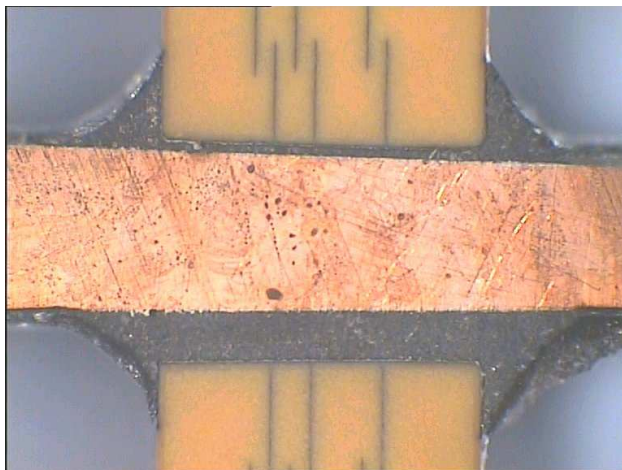

**FIG 18**

Example of force cooled  
50Pb/50In solder joint showing  
absence of any cracks

### 5.B. 50Pb/50In Sample 2 (Gradual cooling)

None of the joints sectioned exhibited any sign of induced cracks in the ceramic.



**FIG 19**

Example of 50Pb/50In solder joint  
showing absence of any cracks

## 6. Solder Type 95Pb / 5In

### 6.A. 95Pb/5In Sample 1 (Forced cooling)

None of the joints sectioned exhibited any sign of induced cracks in the ceramic.

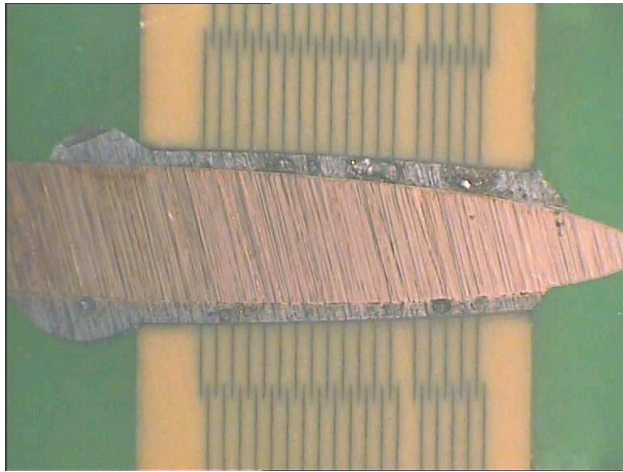

**FIG 20**

Example of force cooled  
95Pb/5In solder joint showing  
absence of any cracks

### 6.B. 95Pb/5In Sample 2 (Gradual cooling)

None of the joints sectioned exhibited any sign of induced cracks in the ceramic.



**FIG 21**

Example of 95Pb/5In solder joint  
showing absence of any cracks

## 7. Solder Type 93.5Pb/5Sn/1.5Ag

### 7.A. 93.5Pb/5Sn/1.5Ag Sample 1 (Forced cooling)

10% of the joints inspected showed very small longbow cracks adjacent to the solder joint. These were noticeably smaller than the cracks seen in other samples.

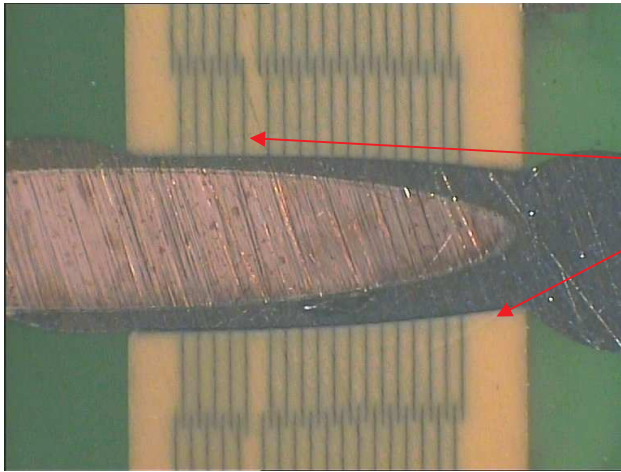
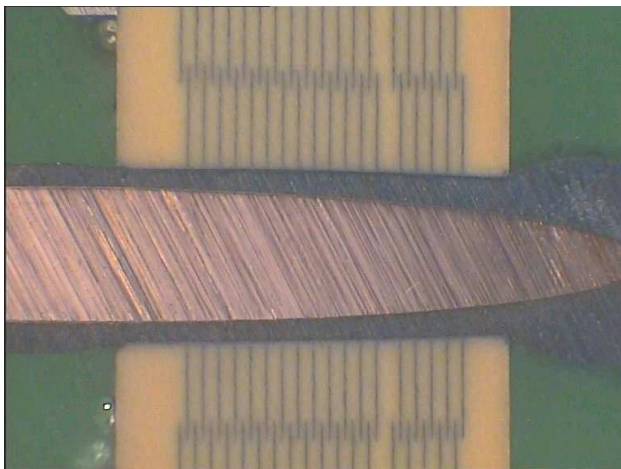

**FIG 22**

Example of 93.5Pb/5Sn/1.5Ag solder joint showing small longbow cracks.

### 7.B. 93.5Pb/5Sn/1.5Ag Sample 2 (Gradual cooling)

None of the joints sectioned exhibited any sign of induced cracks in the ceramic.



**FIG 23**

Example of 93.5Pb/5Sn/1.5Ag solder joint showing absence of any cracks

 <p><b>SYFER</b> SYFER TECHNOLOGY LIMITED A DOVER Company</p>	<p>Application Note Reference No. AN0011 Solder Alloy choice for through hole ceramic discoidal &amp; planar array capacitors Issue 3</p>	<p>Page No.: 17 of 28</p>
--	---	---------------------------

## Results Summary

Alloy Type	Cooling	% Defective 'Longbow' only	% Defective Total
62Sn/36Pb/2Ag	Forced	80	100
	Gradual	20	60
60Sn/40Pb	Forced	100	100
	Gradual	60	80
99.3Sn/0.7Cu	Forced	100	100
	Gradual	100	100
95.5Sn/3.8Ag/0.7Cu	Forced	100	100
	Gradual	40	80
50Pb/50In	Forced	0	0
	Gradual	0	0
95Pb/5In	Forced	0	0
	Gradual	0	0
93.5Pb/5Sn/1.5Ag	Forced	10	10
	Gradual	0	0

Note :-

The HMP solder joints were made using capacitors without solder pads as available jigging did not allow padded parts to be assembled. This eliminated corner cracking and may have slightly distorted the results with respect to this. However, the very low level of longbow cracking found in HMP soldered parts (10% of force cooled 93.5Pb/5Sn/1.5Ag joints only) still indicates the improved performance of these alloys.



Application Note  
Reference No. AN0011  
Solder Alloy choice for  
through hole ceramic  
discoidal & planar array  
capacitors Issue 3

Page No.: 18 of 28

### Demonstration of effect with PdAg termination

PdAg terminations raise another problem with soldering to through holes in ceramic - the termination to ceramic bond is reduced when compared to gold plating. The effect of this is that the contraction forces tend to stress relieve the assembly at the termination / ceramic interface rather than inside the ceramic structure in the form of a crack.

On the face of it, this may appear better than a potentially fatal crack, but it raises a potentially more worrying concern.

If a ceramic capacitor is cracked, and subsequently fails, then the resulting fail is almost always a short circuit IR failure. This is normally immediately apparent and the resulting failure can be isolated and removed.

Failure of the termination / ceramic interface will tend not to cause an immediate obvious failure, but will instead result in loss of the filtering performance, often due to dropping capacitance. There have been cases of total loss of filtering due to total failure of the termination / ceramic interface. Loss of filtering may not be immediately apparent, but the effect on the performance of the overall system can be far worse.

Testing PdAg termination and Pb free solder alloy

To demonstrate the problems experienced with soldering to PdAg termination it is easiest to consider a design of capacitor where the capacitance is constructed without electrodes connected to the through hole.

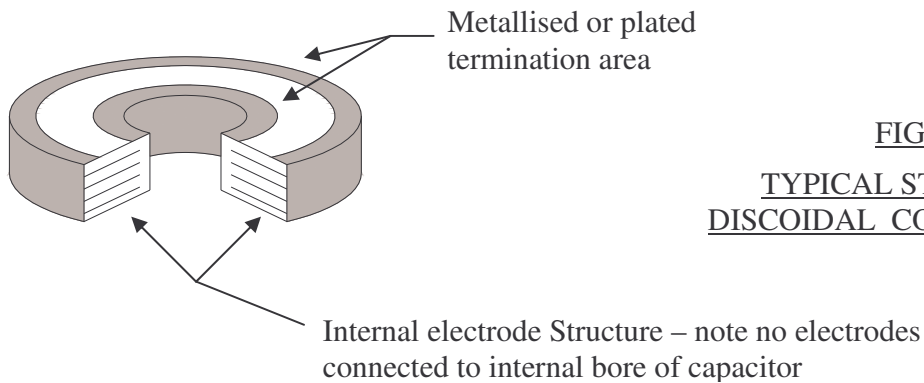

FIG 24  
TYPICAL STRAY CAP.  
DISCOIDAL CONSTRUCTION

The capacitance is created by the interaction of the internal bore termination and the outer earth electrodes.

The advantage of carrying out experiments with this type of construction is that any failure of the internal termination or ceramic cracking is demonstrated by a drop in the capacitance. This is because of the introduction of an alternative dielectric material – air – in the area of the failure.

Tests were carried out using capacitor arrays with the electrical design shown above and terminated with PdAg termination material. Prior to assembly, the capacitance of the holes with this design was recorded. The assembly was soldered using 95.5Sn/3.8Ag/0.7Cu solder and hot air reflow. After assembly, the capacitance was re-measured and the results tabulated below.



Test Results

Array No. 1			Array No. 2		
Start Capacitance (pF)	Capacitance after Soldering (pF)	Change (%)	Start Capacitance	Capacitance after Soldering	Change
551	296	-46.3	539	331	-38.6
550	242	-56.0	540	256	-52.6
550	300	-45.5	535	196	-63.4
552	249	-54.9	536	189	-64.7
553	244	-55.9	532	323	-39.3
546	474	-13.2	538	151	-71.9
544	351	-35.5	536	91	-83.0
543	418	-23.0	539	175	-67.5
551	339	-38.5	544	353	-35.1
551	520	-5.6	536	168	-68.7
546	368	-32.6	536	176	-67.2
550	289	-47.5	534	317	-40.6
544	451	-17.1	544	173	-68.2
544	443	-18.6	543	153	-71.8
550	242	-56.0	543	285	-47.5

Array No. 1

Mean Drop = 36.5%

Maximum Drop = 56.0%

Array No. 2

Mean Drop = 58.7%

Maximum Drop = 83.0%

### Analysis of the Cause of failure

The capacitor arrays were surface sectioned to check for the presence of cracks in the ceramic. Using this method of sectioning analysis allows us to investigate all solder joints at once. If cracks are found, they will be of the 'Comma' variety described above.

Surface sectioning of both arrays found no ceramic cracks.

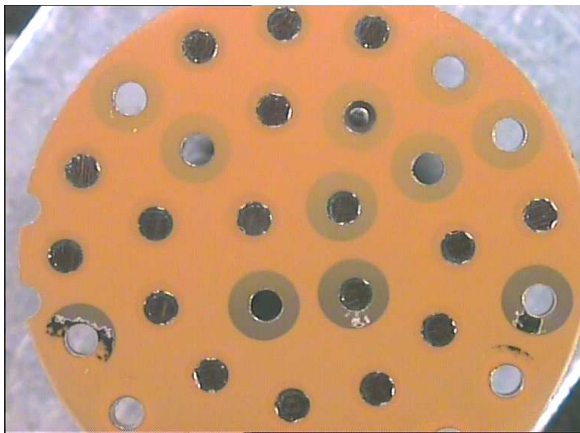

FIG 25

Surface Section of Array No. 2  
showing absence of damage to  
ceramic

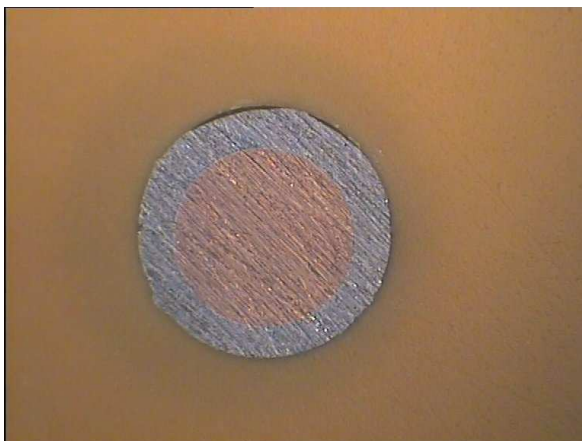

FIG 26

Close-up of Surface Section of Array  
No. 1 showing absence of damage to  
ceramic

We can therefore conclude that the capacitance loss is not caused by cracks within the ceramic in the same way that gold terminated parts are affected.

One effect that can be seen from the surface sections above is that of solder / termination pull – away from the bore of the ceramic. This has the same effect as the cracks in gold plated parts, introducing a section of air dielectric within the capacitor build.

This effect can be seen in FIG 26 above. A further example is below :-

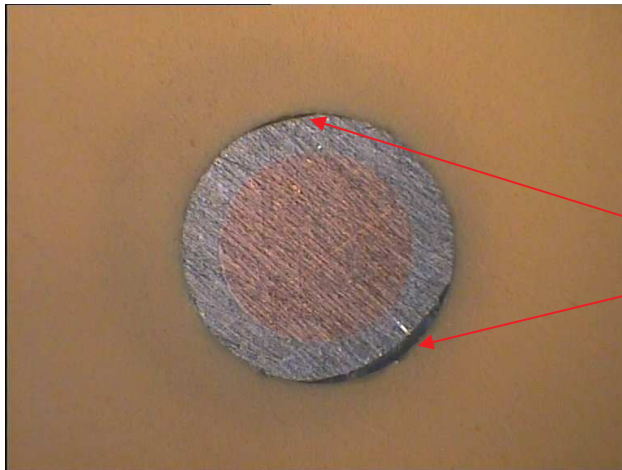

FIG 27

Second Close-up of Surface Section of Array No. 1 showing absence of damage to ceramic, but evidence of pull away of solder / termination from ceramic surface.

It is our conclusion that the unacceptable capacitance drop is caused by the failure of the termination / ceramic bond when exposed to excessive stress force as the solder / pin joint cools.

## Analysis of the differences between gold plate and PdAg terminations

To understand the failure mode above, it is necessary to investigate the differences between PdAg termination and gold plate.

1. With PdAg termination, the bond to the ceramic is far weaker than gold plate termination. This can be demonstrated by a simple pull test, as below.

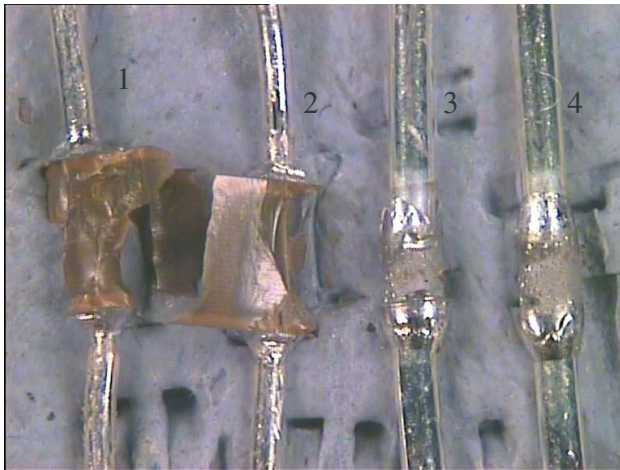

FIG 28

Silver plated copper pins soldered into planar array capacitors using 95.5Sn/3.8Ag/0.7Cu solder and removed by simply pulling out using a pair of pliers.

Pins 1 & 2 have been pulled from an array terminated with gold plate.

Pins 3 & 4 have been pulled from an array terminated with PdAg fritted termination.

As can be seen above, the gold plated termination has a far greater adhesion to the ceramic, demonstrated by the amount of ceramic material still attached to the pin. By comparison, the PdAg termination has been cleanly removed from the ceramic with no ceramic material removed. Pins 3 and 4 do show the PdAg termination still attached to the solder – identified by the dull grey areas on the solder.

This is further shown in FIG 29, where the pins have been removed from a partially sectioned array soldered with PdAg termination.

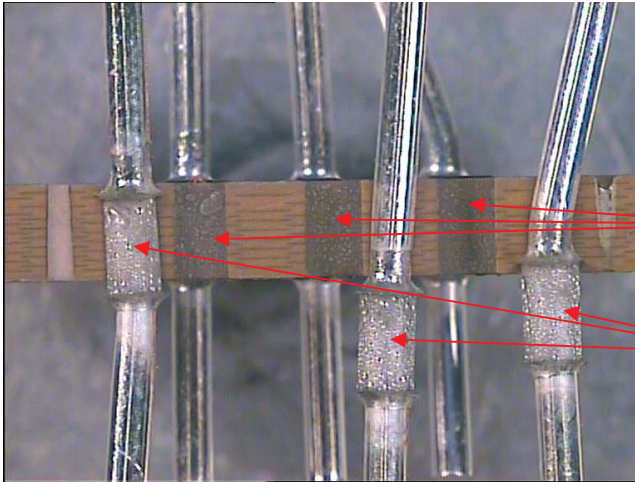

Fig 29

Example of PdAg terminated planar array capacitor soldered with 95.5Sn/3.8Ag/0.7Cu solder.

As the component is sectioned, the pins can be easily removed without damage to the ceramic.

Note the dark grey on the solder joint – this is the termination, which has been removed along with the pin & solder.

The ceramic exhibits no damage, and the pins are very easily removed – the termination has relatively little adhesion to the ceramic.

2. Secondly, PdAg termination is far more susceptible to leaching into the molten solder as the joint is formed. In sectioned components, this is observed as areas of missing termination within the bore of the component.

Leaching is far more common with Pb free alloys, and has been observed on PdAg terminated components with all Pb free alloys. The following examples have been soldered using 95.5Sn/3.8Ag/0.7Cu solder alloy.

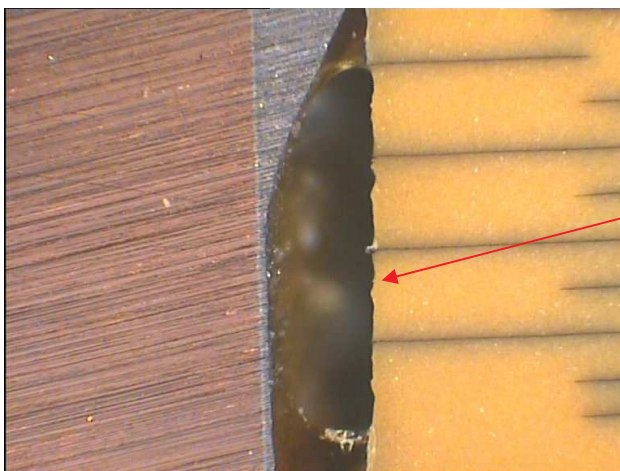

FIG 30

Termination leached away from this area.

These electrodes have lost contact and will result in a potential reduction in filtering performance.

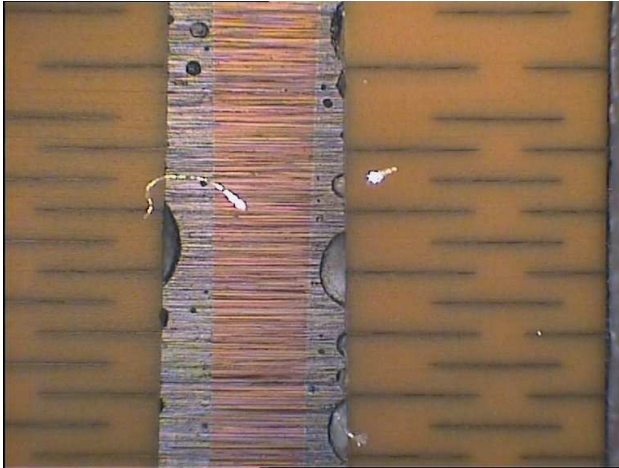

FIG 31

Further example of leaching  
and poor solder joint with  
PdAg termination.

This leaching also has the effect of reducing the termination adhesion between the termination and the ceramic.



### Comments on fritted termination in discoidal and planar capacitors

From this analysis it is clear that PdAg terminations are not suitable for through hole ceramic devices when soldered with lead free solder alloys. Although the ceramic does not crack in the same way as gold plated terminated parts do, the joint between the termination and the ceramic is compromised resulting in a parametric failure.

It is important to also understand that the results given in this paper only represent analysis after the soldering operation. It is normal practise for this type of component to be subjected to positive and negative thermal excursions during testing and operation. It is reasonable to expect that the effect can propagate during these excursions, with the possible conclusion of total joint failure.

The possible loss of up to 83% of design capacitance is clearly unacceptable, but may not be immediately apparent in operation. Components which have had cracks induced (i.e. gold plated termination) are likely to fail short circuit – a failure mode that is immediately observed allowing the failed component to be isolated and removed.

Parametric failure, such as loss of capacitance, is a far more insidious failure mode in that it may not be easily detected, but can cause serious and significant problems in operation.

In the example above, the design capacitance is 500pF, giving a typical PI filter (1000pF total) insertion loss of 6dB @ 10MHz. If we assume that this capacitance can drop to typically 250pF (500pF total - 50% drop), then the resultant insertion loss will only be in the region of 2dB @ 10Mhz. The generally accepted cut-off point for a filter to be operating is 3dB. In it's failed form the filter is not acting as such.

This failure may not be immediately critical, but the filter is not working to it's design performance. If at some point in time, the filtering performance at this frequency is critical, then the performance is not available.

## Conclusions

1. Potentially fatal cracks were found in all assemblies manufactured with both conventional tin lead solders and the proposed lead free alloys and gold plated termination.
2. Tin lead alloys induced cracks in the ceramic dielectric and should not be used for the manufacture of these assemblies.
3. Lead free alloys performed worse of all solders under test, and should not be used for the manufacture of these assemblies. The lead free alloys tended to perform worse than the tin lead alloys – more cracks and larger cracks were found.
4. In order to manufacture reliable safe capacitor assemblies, it is essential to use a ductile solder so as to prevent excessive force being transferred to the ceramic dielectric material. Ductile solders tend to be an alloy of lead and indium.
5. High melting point alloys, typically containing >90% lead and melting around 300°C, are acceptable if indium is to be avoided - but have a narrower processing window and are more susceptible to problems if the cooling rate is not controlled.
6. Solder joint design should be given due consideration. In particular, solder pads should be reduced or minimised (Note – the manufacture and testing of the capacitor itself will sometimes demand solder pads are included)
7. Gradual cooling should be used and force cooling, either intentional or unintentional due to factors such as drafts, should be avoided.
8. PdAg terminations reduce the incidence of ceramic cracking, but may result instead in parametric failure of the capacitor. This can be ultimately worse in service.
9. It is clear that there is a conundrum – if the termination system provides a very good bond to the ceramic, then there is a risk of cracking the ceramic. If the termination system provides a weak bond to the ceramic then there is a risk of parametric failure leading to loss of performance.
10. The best option for reliable performance is to use a termination system that provides a very strong bond to the ceramic (e.g. gold) and introduce stress relief through the use of ductile solders.

 <p><b>SYFER</b> SYFER TECHNOLOGY LIMITED A DOVER Company</p>	Application Note Reference No. AN0011 Solder Alloy choice for through hole ceramic discoidal & planar array capacitors Issue 3	Page No.: 28 of 28
--	---	--------------------

## RoHS compliance

EU directive 2002/95/EC, commonly known as RoHS directive, limits the use of certain substances in electronics manufacture. These substances include lead, which has forced a change from lead containing solders to lead free solders for a majority of applications.

Clearly from the evidence shown above, the use of lead free solders should be avoided when soldering to ceramic discoidal and planar capacitors.

The directive allows for exemptions to be granted for situations where there is no technical alternative or such alternatives constitute a negative environmental impact. Syfer have successfully applied for the use of lead containing solders for soldering to ceramic planar arrays and discoidal capacitors to be made exempt from the directive.

This exemption is detailed in the annex to 2002/95/EC as follows :-

Exemption No. 24      Lead in solders for the soldering to machined through hole discoidal and planar array ceramic multilayer capacitors.

Issued in the addendum to the directive dated 14<sup>th</sup> October 2006

To summarise – Filters, filter assemblies and filtered connectors manufactured with Syfer discoidal and planar capacitors can be assembled using lead bearing solder alloys – i.e. InPb – to eliminate the incidence of micro cracking due to mismatched material shrinkages and still be RoHS compliant in this respect.